



Commissioning guide

XPander

Commissioning Guide

Introduction

XPander is a range of addressable multi-state detectors and associated products developed to enhance the capabilities of the Apollo addressable range of products.

It is a range of products that connect to an XP95, Discovery or Soteria system using an interface that is wired to the loop. The interface communicates with the field devices by means of radio signals.

Each loop-powered interface can control up to 31 wireless XPander devices, each assigned a loop address.

The purpose of this guide is to provide information on commissioning and troubleshooting an XPander installation and should be read in conjunction with the guides that follow, all of which are available from www.apollo-fire.co.uk:

- PP2322 - XPander Radio Site Survey Sheet
- PP2323 - XPander Site Survey Instructions
- PP2279 - XPander Manual Call Point Installation Guide
- PP2280 - XPander Loop Interface Installation Guide
- PP2367 - XPander Input/Output Unit Installation Guide
- 39214-394 - XPander Smoke and Heat Detectors Installation Guide
- 39214-444 - XPander Sounder/Visual Indicator Installation Guide
- 39214-739 - XPander Combined Sounder/Sounder Visual Indicator and Detector Installation Guide

A maximum of five interfaces is permitted for each site. For sites that require more than five interfaces please contact Apollo.

All of the products in the XPander range are CPR approved and CE marked. The entire range is also approved to EN 54-25 - the European Standard for radio equipment used in fire systems.

System features

Addressing

XPander detectors are addressed by means of the XPander XPERT card which is familiar to users of XP95, Discovery and Soteria systems. The XPander XPERT card is specifically designed for XPander products having profiled address pips for ease of installation.

Polling

XPander detectors and alarm devices are polled in the same way as devices connected directly to the loop. They respond in exactly the same way and provide the same categories of information.

Radio communications

Fire detection systems are life-saving systems and must, therefore, be highly reliable in use. Radio communications have been developed to a point where high reliability can be guaranteed.

Frequency

The radio frequency used by XPander systems is 868 MHz - the harmonised European frequency.

Signal integrity

Use of 'extra strength' signals means that XPander systems maintain their integrity even if minor changes, such as moving the furniture, are made. The XPander Diversity Interface has multiple aerials positioned at different angles within the loop interface. This means the interface is able to intelligently and dynamically select the radio communication path with the lowest destructive reflections and the best signal strength.

Interference

To help eliminate interference from other sources such as police or ambulance radio systems the XPander system uses a narrow band signal with additional coding. This and dual band signalling means the danger of interference has been reduced to a point of becoming negligible.

Battery monitoring

Devices in the XPander range are powered by batteries. There are two battery packs with current being drawn alternatively from each. It is essential that the state of the batteries is known and therefore the three states that follow have been defined:

Normal	Batteries in good working order
Fault*	Batteries need to be changed
Missing**	Battery voltage very low or battery pack incorrectly fitted

* For the 'Fault' state a warning is sent 30 days before battery failure.

** For the 'Missing' state a warning is sent seven days before battery failure.

When changing the batteries, both packs within the device should be changed at the same time.

Battery life is typically between three and five years but Apollo can only guarantee this if the recommended replacement alkaline batteries are used. It is recommended that the batteries are changed during the year four maintenance period.

Batteries should be disposed of in accordance with local regulations.

Handling

As with all electronics, care should be taken during handling. Avoid dropping any of the parts onto hard surfaces as damage may occur to the device case and internal circuitry.

To minimise the risk of damage all products should be kept in their packaging until they are installed. Retain all packaging until the installation and commissioning is complete.

Observe anti-static precautions when handling all products. To avoid the risk of static discharge do not place sensitive devices on plastic surfaces.

All packaging is recyclable.

XPander product range

All XPander detectors are supplied as complete units with a mounting base. The range is made up of the products that follow:

Product	Heat Detector A1R with base
Part No.	XPA-CB-11170-APO
Product	Heat Detector CS with base
Part No.	XPA-CB-11171-APO
Product	Optical Smoke Detector with base
Part No.	XPA-12034-APO
Product	Red sounder with mounting base
Part No.	XPA-CB-14001-APO

Product	White sounder with mounting base
Part No.	XPA-CB-14002-APO
Product	Red sounder visual indicator with red mounting base
Part No.	XPA-CB-14003-APO
Product	Amber sounder visual indicator with white mounting base
Part No.	XPA-CB-14004-APO
Product	Clear sounder visual indicator with white mounting base
Part No.	XPA-CB-14005-APO
Product	Combined sounder and optical smoke detector
Part No.	XPA-CB-14016-APO
Product	Combined sounder and A1R heat detector
Part No.	XPA-14017-APO
Product	Combined sounder and CS heat detector
Part No.	XPA-CB-14018-APO
Product	Combined sounder visual indicator (red) with optical smoke detector
Part No.	XPA-CB-14020-APO
Product	Combined sounder visual indicator (red) with A1R heat detector
Part No.	XPA-CB-14021-APO
Product	Combined sounder visual indicator (red) with CS heat detector
Part No.	XPA-CB-14022-APO
Product	Combined sounder visual indicator (clear) with optical smoke detector
Part No.	XPA-CB-14024-APO
Product	Combined sounder visual indicator (clear) with A1R heat detector
Part No.	XPA-CB-14025-APO
Product	Combined sounder visual indicator (clear) with CS heat detector
Part No.	XPA-CB-14026-APO
Product	Single input/output unit
Part No.	XPA-IN-14011-APO
Product	Dual input/output unit
Part No.	XPA-IN-14012-APO
Product	Diversity loop interface
Part No.	XPA-IN-14050-APO
Product	Remote indicator module
Part No.	XPA-IN-14102-APO
Product	Manual call point
Part No.	XPA-MC-14006-APO
Product	Site Survey Kit
Part No.	XPA-TE-14075-APO
Product	Red XPander XPERT card
Part No.	29600-399
Product	White XPander XPERT card
Part No.	29600-413

Quick Start Guide for XPander Diversity Site Survey

- | | | |
|--|---|--|
| 1. Use the site survey tool to check the signal strength. | → | For detailed instructions refer to page 14 |
| 2. Record all the survey signal strengths on the site survey sheet. | → | For the site survey sheet refer to page 15 |
| 3. Fit the interfaces as per the instructions in the Quick Start guide | → | See Quick Start Guide for XPander Diversity Loop Interface below |
| 4. Log the devices on to the interface as per the instructions in the Quick Start guide | → | For detailed instructions refer to page 7 |
| 5. Check the signal strength for each logged on device and record it in the site survey sheet. | → | Refer to the site survey sheet, page 15 |

Quick Start Guide for XPander Diversity Loop Interface

- | | | |
|---|---|---|
| 1. Select the interface number or ID (Range 1 - 5) | → | For detailed instructions refer to page 7 |
| 2. Select channels - refer to Appendix B and the checklist on the inside of the unit. | → | For detailed instructions refer to Appendix B |
| 3. Set the system address | → | For detailed instructions refer to Installation Guide 39214-926 |
| 4. Log on each device to its respective interface | → | For detailed instructions refer to page 7 |

Installation

Installation should be done in accordance with the radio survey and system design. Siting of the XPander devices must be in strict accordance with the survey, failure to do so may result in loss of performance.

Commissioning

When the system has been commissioned in accordance with the instructions in this guide the XPander system should communicate correctly. The completed site survey document and this guide should be kept as commissioning and user documentation to comply with BS 5839-1, Section 2-27 and Sections 5-39 and 40.

After commissioning should the structure of the building change a new site survey will be required along with the completion of a new site survey document.

For ease of commissioning it is suggested that all devices that are to be logged-on to a particular interface are placed within easy reach of the interface. They can be installed on their respective bases once the log-on procedure for that interface has been completed.

Interface controls

Devices are logged-on to the system using the interface controls. To access these controls it is necessary to remove the front cover of the interface unit and access the PCB.

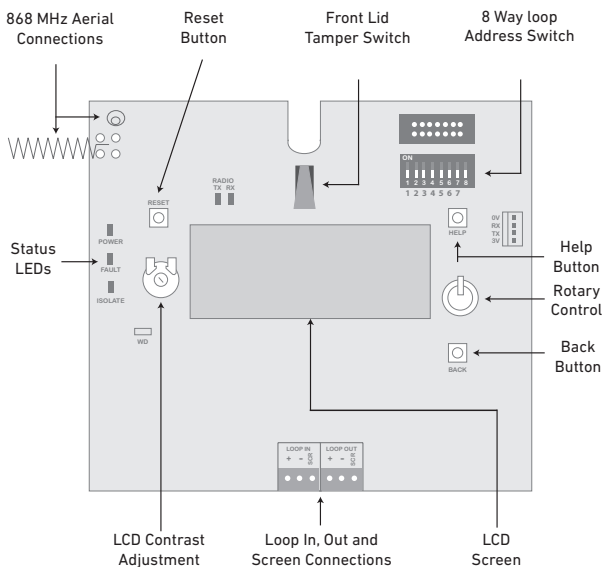

Figure 1: Interface printed circuit board

Devices are logged-on to the system using the Rotary Control as follows:

- Turn the rotary control clockwise to scroll down the menu shown on the LCD.
- Turn the rotary control anti-clockwise to scroll up the menu shown on the LCD.

- Press the rotary control once to select the displayed option.

Logging devices on to the system

Before devices can be logged-on to the system make sure that the batteries are installed correctly and fit the battery jumpers across both header pins as shown below:

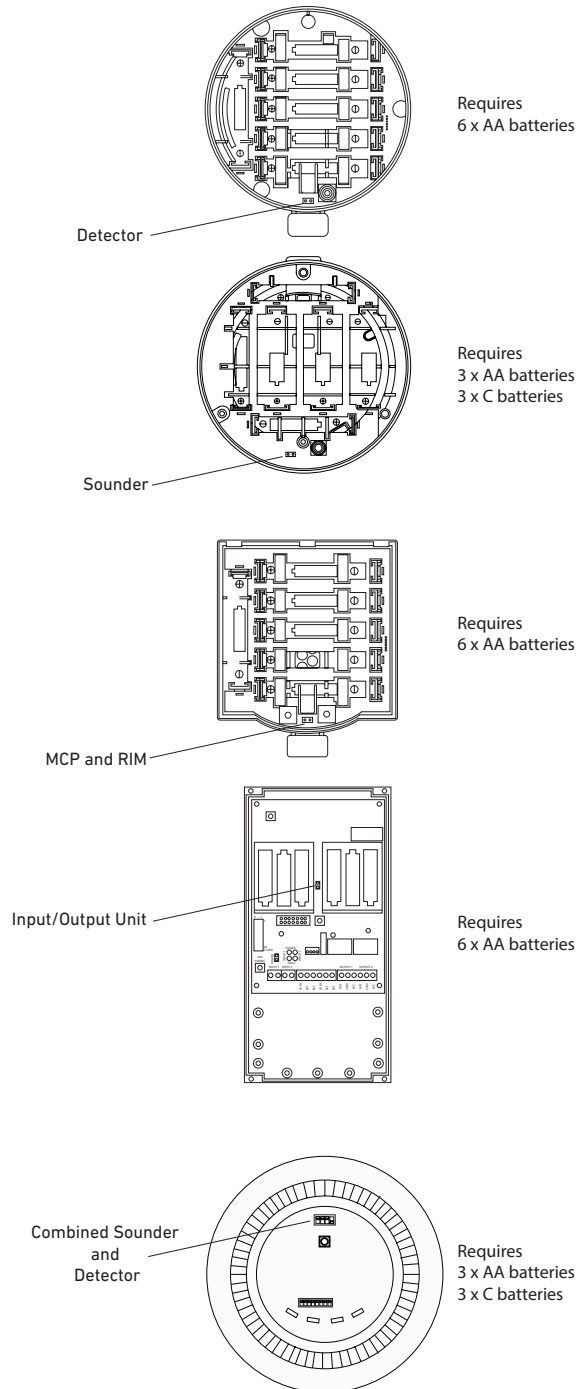

Figure 2: Battery jumper and header pin positions

Note: The XPander Combined Sounder/Visual Indicator uses a DIL switch to connect the battery supply.

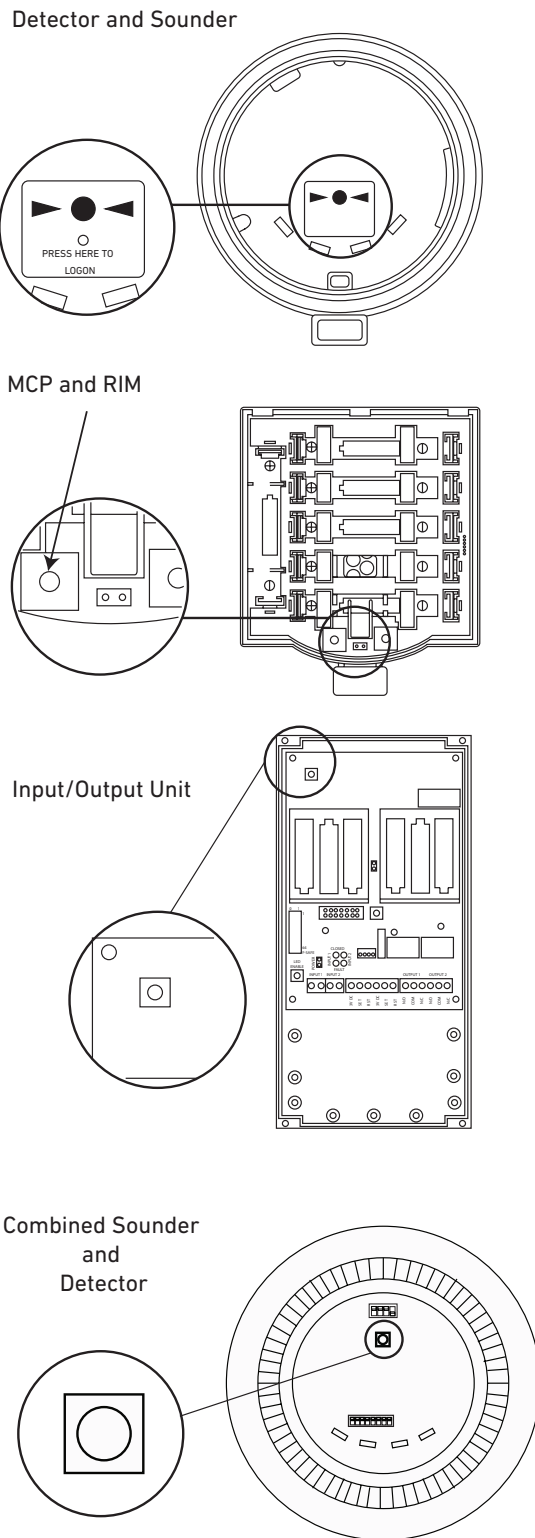

Figure 3 : Device log-on button positions

Logging-on to interfaces

Up to 31 wireless detectors or alarm signalling devices can be assigned to a single interface.

Before adding devices to an interface, make sure the batteries have been inserted correctly, the power jumper has been positioned correctly and the mounting plate fitted.

During the device log-on the interface will request confirmation of the device serial number. Check this on the side of the device radio module.

Make sure the XPander XPERT address card has been fitted before assigning a device to the interface.

In the case of sounders or sounder visual indicators the tone should be selected using the five-segment DIL switch on the base of the device.

To log a device onto the system:

1. On the interface PCB, press and release the rotary control.
2. Turn the rotary control clockwise until 'Add a New Device' is shown on the LCD screen.
3. On the device, press and hold the log-on button for two seconds. The device LED will flash.
4. On the interface LCD screen a five figure code will be shown, for example: A127D This is the unique ID of the device.
5. Check the ID on the screen with the ID label on the device and make sure that they match.
6. Turn the rotary control until 'Yes' appears on the LCD screen.
7. Press and release the rotary control. The LCD screen will show 'Add a New Device'.
8. Do Steps 1 to 7 again until all devices have been logged-on to the interface.
9. Install the devices into their relevant bases.
10. Press the 'Back' button to return to the previous menu.
11. Do Steps 1 to 10 again for each interface on the system.

Multiple interfaces

Interfaces are numbered from one to five. This is not the loop address, it is the frequency ID. For fault-free operation the interfaces must be numbered so that the nearest interface to one is two and the nearest interface to two is three and so on. Start at one end of the site plan and complete the checklist on the interface lid - see Figure 4. The relevant devices can then be logged on to each interface in turn.

Please complete on commissioning			
XPander Interfaces on Site	1st Channel Selected	2nd Channel Selected	Tick
1	Ch 08	Ch 26	
2	Ch 16	Ch 32	
3	Ch 01	Ch 20	
4	Ch 04	Ch 23	
5	Ch 12	Ch 29	
Q.1	If there is more than one XPander Interface on the site: have ALL the channels been set as above?		
Q.2	Has the XPander Interface been installed as per the survey and installation instructions, allowing two metres from electrical equipment and other XPander Interfaces?		
Q.3	Has the aerial been installed as per the survey and installation instructions, allowing 400mm from any metal object or other equipment?		
Q.4	Are ALL the device signal levels 50% or above?		
Q.5	Has the XPander site survey sheet been fully completed?		

Figure 4: Multiple interface channel selection

Menus explained

Menu structure - the Interface menu structure is as follows:

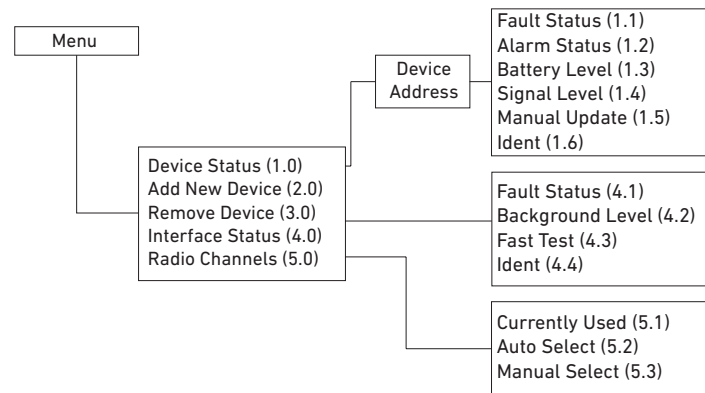

Initial power-up screen - the initial power-up screen shows the details that follow:

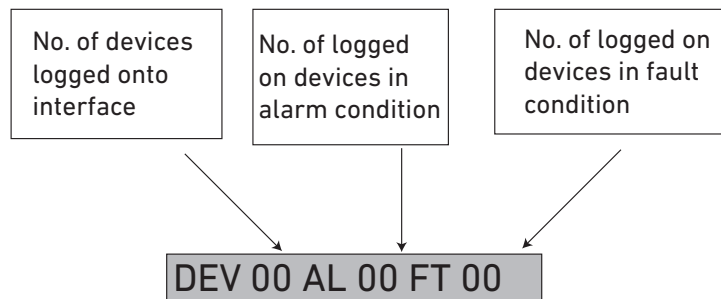

Menu options

Menu Level (1.0)

Device Status
Add New Device
Remove Device
Interface Status
Radio Channels

This menu shows the status of logged-on devices. The loop address as determined by the XPander XPERT card (1 - 126), the logged-on status and type are shown.

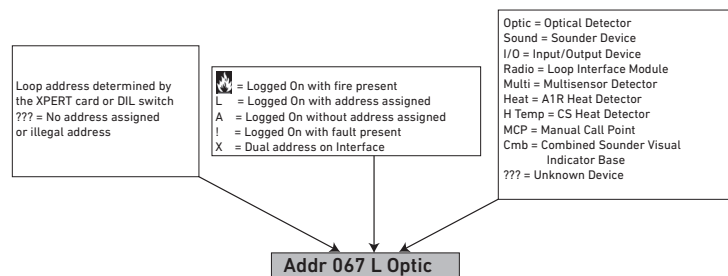

Note: Combined sounder visual indicator base shows two addresses, first address in the detector followed by the sounder visual indicator as shown below.

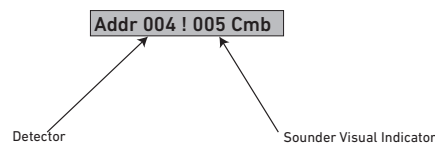

Menu Level (1.0)
 cont'd

Fault Status 1.1	Further information on each device can be viewed by pressing then turning the rotary control
Alarm Status * (1.2)	
Battery Level (1.3)	* Input status on Input/Output Unit
Signal Level (1.4)	** Combine Sounder Visual Indicator Base only
Manual Update (1.5)	
Ident (1.6)	
Type ** (1.7)	

Menu Level (1.1)

Fault Status	This menu shows detailed information on the fault status of the device. If multiple faults are present, these can be viewed by turning the rotary control .
Alarm Status	
Battery Level	
Signal Level	
Manual Update	
Ident	

Menu Level (1.2)	This menu shows the alarm status of the device. * Input Status on Input/Output Unit - shows the status of the monitored input(s). A switch input 'closed' condition is shown as logic '1'. For a full range of analogue values refer to Appendix A, page 11.
Fault Status	
Alarm Status*	
Battery Level	
Signal Level	
Manual Update	
Ident	

Menu Level (1.3)	This menu shows the status of the two battery packs in a device. Battery conditions are shown as follows:
Fault Status	
Alarm Status	
Battery Level	
Signal Level	
Manual Update	
Ident	

Displayed	Definition	Icon on LCD	Analogue Value at Panel
Pack 1 OK	Pack 1 battery voltage healthy	Full battery icon	25 (Detectors) 16 (Sounders and MCPs)
Pack 1 Warning*	Pack 1, 30 day warning	Half battery icon	7
Pack 1 Low	Pack 1, 7 day warning	Half battery icon	7
Pack 1 Missing	No battery pack fitted	X	0
Pack 2 OK	Pack 1 battery voltage healthy	Full battery icon	25 (Detectors) 16 (Sounders and MCPs)
Pack 2 Warning*	Pack 1, 30 day warning	Half battery icon	7
Pack 2 Low	Pack 1, 7 day warning	Half battery icon	7
Pack 2 Missing	No battery pack fitted	X	0

* Batteries need to be changed as soon as possible

Notes: When replacement batteries are required all batteries must be replaced together

To achieve the typical battery life of between three and five years, Apollo recommends the use of Panasonic® Powerline or Varta® Industrial alkaline batteries.

Menu Level (1.4)

Fault Status
Alarm Status
Battery Level
Signal Level
Manual Update
Ident

This menu shows the status of the two signalling channels used by the loop interface and the communicating device. If more than one interface is used, please refer to Appendix B, page 11.

The received signal strength at the loop interface from the device is shown as L1 ← D followed by a percentage indicating the signal strength. Similarly the received signal at the device is shown as L1 → D followed by the signal strength.

If you have moved or re-installed a device, complete a manual update before checking the signal level.

The L1 ← D level is updated every 300 seconds. The L1 → D level is updated every 12 hours or when requested manually by selecting the 'Manual Update' option described below.

Ch 1 LI ← D = Device to Interface signal on channel 1
Ch 2 LI ← D = Device to Interface signal on channel 2
Ch 1 LI → D = Interface to Device signal on channel 1
Ch 2 LI → D = Interface to Device signal on channel 2

60 - 100 = Good signal level
50 - 59 = Medium Signal level*
40 - 49 = Low Signal level
30 - 39 = Caution Signal level
10 - 29 = Fault Signal Level
0 = No Signal level

LI ← D XXX

Menu Level (1.5)

Fault Status
Alarm Status
Battery Level
Signal Level
Manual Update
Ident

When selected the status of all devices is updated. The current status can then be viewed as described in the 'Signal Level' Menu.

Menu Level (1.6)

Fault Status
Alarm Status
Battery Level
Signal Level
Manual Update
Ident

This menu shows the unique five digit identification number for the device. This may be recorded on site drawings or the radio survey document for maintenance purposes.

Menu Level (1.7)

Fault Status
Alarm Status
Battery Level
Signal Level
Manual Update
Ident
Type

This menu indicates the detector type on a Combined Sounder Visual Indicator Base.

Menu Level (2.0)

Device Status
Add New Device
Remove Device
Interface Status
Radio Channels

From this menu new or additional devices can be logged on to the interface. Up to 31 devices can be logged on to each interface.

Menu Level (3.0)

Device Status
Add New Device
Remove Device
Interface Status
Radio Channels

This menu shows a list of devices logged on to the interface. To remove a device use the rotary control to select it and press to confirm. Make sure this has been done before physically removing the device.

Caution: Once devices have been removed they will no longer be able to signal an alarm. If a device is permanently removed it will also need to be removed from the control panel.

Menu Level (4.0)

Device Status
Add New Device
Remove Device
Interface Status
Radio Channels

From this menu the status of the loop interface and background noise can be viewed.

Menu Level (4.1)

Fault Status
Background Level
Fast Test
Ident

This menu shows detailed information on the fault status of the interface. If multiple faults are present they can be individually viewed by using the rotary control.

For a full range of analogue values please refer to Appendix B, page 11.

Menu Level (4.2)

Fault Status
Background Level
Fast Test
Ident

The background noise level on the two signalling channels can be viewed.

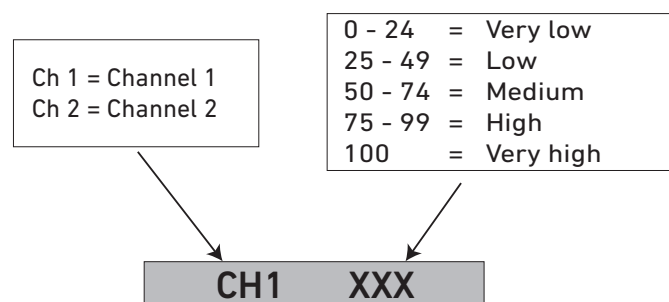

Menu Level (4.3)

Fault Status
Background Level
Fast Test
Ident

XPander detectors incorporate algorithms to minimise unwanted alarms whilst maintaining a high level of protection. The FastTest® function reduces the number of detection samples required for an alarm condition therefore making it quicker to test detectors. When FasTest is selected the devices LED will flash once per second. After a pre-selected period of time the device will return to normal operating mode. This period applies to all detectors logged on to the interface. Once selected a count-down time is shown. On receipt of an alarm from a detector the timer resets the period selected and resumes the countdown. If no alarm is received the interface and detectors return to their normal operating mode.

Menu Level (4.4)

Fault Status
Background Level
Fast Test
Ident

This menu shows the unique identification number of the interface.

Menu Level (5.0)

Device Status
Add New Device
Remove Device
Interface Status
Radio Channels

From this menu it is possible to view and/or select the two signalling channels manually from the 32 available. The default setting is automatic channel selection and the interface defaults to CH8 and CH26 for communication. The default setting should be altered if multiple interfaces are being used on site. A maximum of five interfaces can be used in any one site. If more are required please contact Apollo.

The menu devices available will depend on whether devices are logged on to the interface. Manual channel select is only accessible when **no devices are logged on** the interface. If devices are logged on only the 'Currently Used' option is shown.

See Appendix B for a full list of frequencies.

Menu Level (5.1)

Currently Used
Auto Select
Manual Select

When selected the currently used frequencies for CH1 and CH2 are shown. If more than one interface is being used, refer to before logging on the devices and make sure to follow the instructions given for the selection of frequencies which is printed on the lid of the unit.

Menu Level (5.2)

Currently Used
Auto Select
Manual Select

This does not detect communications from other XPander devices. It will scan for other sources of background noise. The auto selected channels should not be used when multiple interfaces are fitted, only the channels given in Appendix B

This function should not be used without consulting Apollo.

Menu Level (5.3)

Currently Used
Auto Select
Manual Select

Radio channels should be manually selected when more than one interface is installed on a system (see Multiple Interfaces on page). Channel information is shown on both the lid of the interface and in Appendix B.

Select 'First Channel' and scroll to the desired channel and enter. Do this procedure again for 'Second Channel'. Channel selection must be done before devices are logged on.

Note: Menu Levels 5.2 and 5.3 are not available if devices are logged on to the interface.

Appendix A

The devices return an analogue value depending on their state. The table that follows shows these analogue values (AV) and their definitions.

AV	Definition
0	Battery packs A and B missing
1	Detector fault, sounder audio fault
2	Detector head missing
3	Sounder missing
4	Tamper
5	Signal strength fault, background RSSI out of range - interface
6	Not used
7	Battery fault 30 days, A and B
8 - 12	Not used
13	Signal strength poor
14	Signal strength low
15	Not used
16	Normal - MCP, sounder, loop interface, I/O Unit, Remote Indicator Module
17- 19	Not used
20	Signal strength medium - detector
21- 24	Not used
25	Signal strength good - detector
26 - 34	Not used - detector
35	Head dirty - detector
36 - 49	Not Used
50	Pre-alarm - detector
51 - 63	Not used
64	Alarm - MCP
65 - 84	Not used
85	Alarm - detector

Note: No response to polling indicates an RF comms failure

Appendix B

Radio channels

Ch 1:	868.048 MHz	Ch 17:	868.479 MHz
Ch 2:	868.073 MHz	Ch 18:	868.774 MHz
Ch 3:	868.098 MHz	Ch 19:	868.800 MHz
Ch 4:	868.123 MHz	Ch 20:	868.825 MHz
Ch 5:	868.148 MHz	Ch 21:	868.850 MHz
Ch 6:	868.173 MHz	Ch 22:	868.875 MHz
Ch 7:	868.198 MHz	Ch 23:	868.900 MHz
Ch 8:	868.223 MHz*	Ch 24:	868.925 MHz
Ch 9:	868.248 MHz	Ch 25:	868.950 MHz
Ch 10:	868.273 MHz	Ch 26:	868.975 MHz*
Ch 11:	868.298 MHz	Ch 27:	869.000 MHz
Ch 12:	868.323 MHz	Ch 28:	869.025 MHz
Ch 13:	868.349 MHz	Ch 29:	869.050 MHz
Ch 14:	868.374 MHz	Ch 30:	869.075 MHz
Ch 15:	868.399 MHz	Ch 31:	869.100 MHz
Ch 16:	868.424 MHz	Ch 32:	869.125 MHz

* Denotes default channel on power-up

This page has intentionally been left blank

